

# Cutwise

## Integration

DiBox 2.0

On octonus

LDX7

# Current Solutions

VISION360™

Diamond ID :1824480121

360° View Report 360° View

Terms of Use

Vision360

**SARINE**

Shape Round Carat 2.02 Color I Clarity SI1 Cut EX

Graded by GIA  
Information provided by 3<sup>rd</sup> party

*Explore This Diamond Story*

Beauty Mark Light Loupe Inscription

Conditions

Powered by SARINE

Sarine Profile

Round on Black background

























Shape	Size	Clarity	Lab
Round	5.01	VS2	GIA

View Certificate

DIACAM360

Diacam360

# Current Solutions

Compare	Shape	Price	Carat	Cut	Color	Clarity	Delivery Date
☆	 Round	\$4,121	1.00	Ideal	F	SI2	Jul 12
☆	 Round	\$4,145	1.00	Ideal	F	SI2	Jul 12
☆	 Round	\$4,184	1.00	Ideal	F	SI2	Jul 9
☆	 Round	\$4,215	1.00	Ideal	F	SI2	Jul 12
☆	 Round	\$4,321	1.00	Ideal	F	SI2	Jul 12
☆	 Round	\$4,355	1.00	Ideal	F	SI2	Jul 15
☆	 Round	\$4,369	1.00	Ideal	F	SI2	Jul 12
☆	 Round	\$4,371	1.00	Ideal	F	SI2	Jul 12
☆	 Round	\$4,371	1.00	Ideal	F	SI2	Jul 12
☆	 Round	\$4,379	1.00	Ideal	F	SI2	Jul 12
☆	 Round	\$4,407	1.00	Ideal	F	SI2	Jul 12
☆	 Round	\$4,407	1.00	Ideal	F	SI2	Jul 15
☆	 Round	\$4,514	1.00	Ideal	F	SI2	Jul 16
☆	 Round	\$4,519	1.00	Ideal	F	SI2	Jul 12
☆	 Round	\$4,522	1.00	Ideal	F	SI2	Jul 12
☆	 Round	\$4,522	1.00	Ideal	F	SI2	Jul 12
☆	 Round	\$4,523	1.00	Ideal	F	SI2	Jul 15
☆	 Round	\$4,597	1.00	Ideal	F	SI2	Jul 9
☆	 Round	\$4,632	1.00	Ideal	F	SI2	Jul 12
☆	 Round	\$4,639	1.00	Ideal	F	SI2	Jul 12
☆	 Round	\$4,665	1.00	Ideal	F	SI2	Jul 9
☆	 Round	\$4,672	1.00	Ideal	F	SI2	Jul 12
☆	 Round	\$4,672	1.00	Ideal	F	SI2	Jul 12
☆	 Round	\$4,672	1.00	Ideal	F	SI2	Jul 12
☆	 Round	\$4,675	1.00	Ideal	F	SI2	Jul 15

Websites without any videos, only 4C parameters



The most popular videos are 360° rotation



That doesn't have anything common with real life diamonds assessment



Diamonds are estimated in a ring



by swinging the hand with the ring on

Embed similar  
swinging videos  
into your website



Cut Performance	0.93	P	F	G	VG	EX	OU
Optical Symmetry	8.47	P	F	G	VG	EX	OU
Spread	Oct	+0.1%					
Face-up Fluorescence		V STR	STR	MED	FNT	NON	100%

Along with optical  
performance  
evaluation



We provide a wide range of visual data



Office



Fire



Hearts

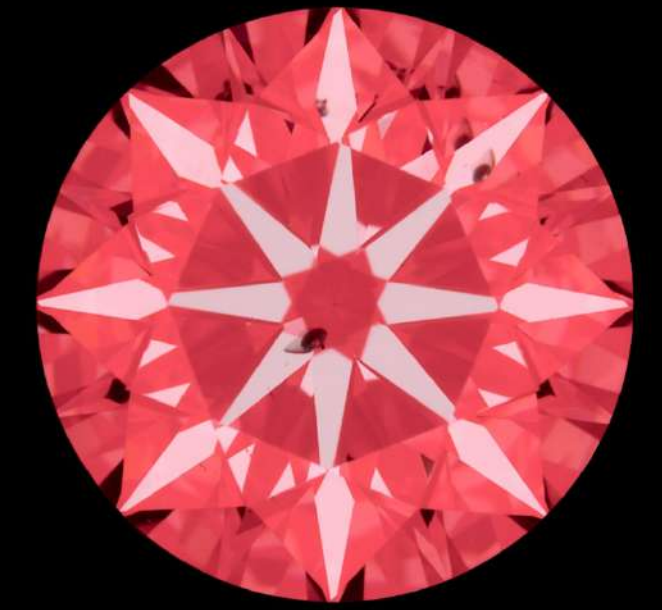

Arrows

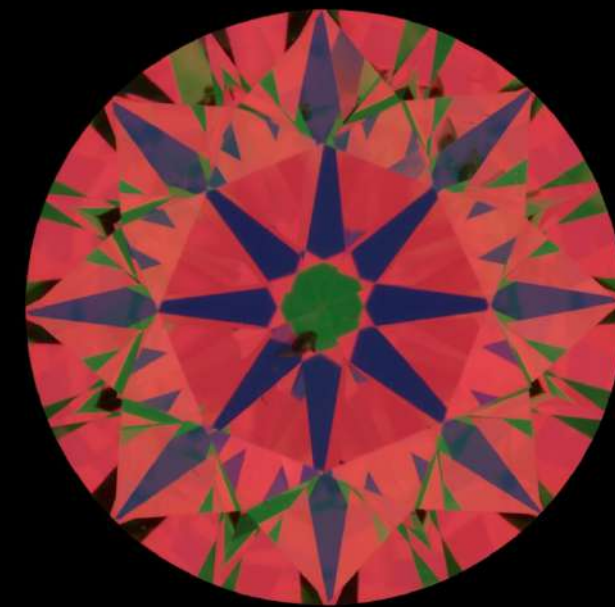

ASET



Darkfield

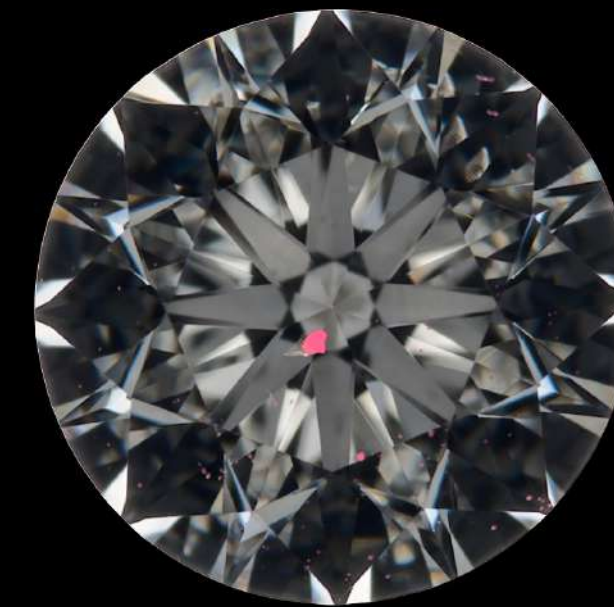

Clarity Plotting

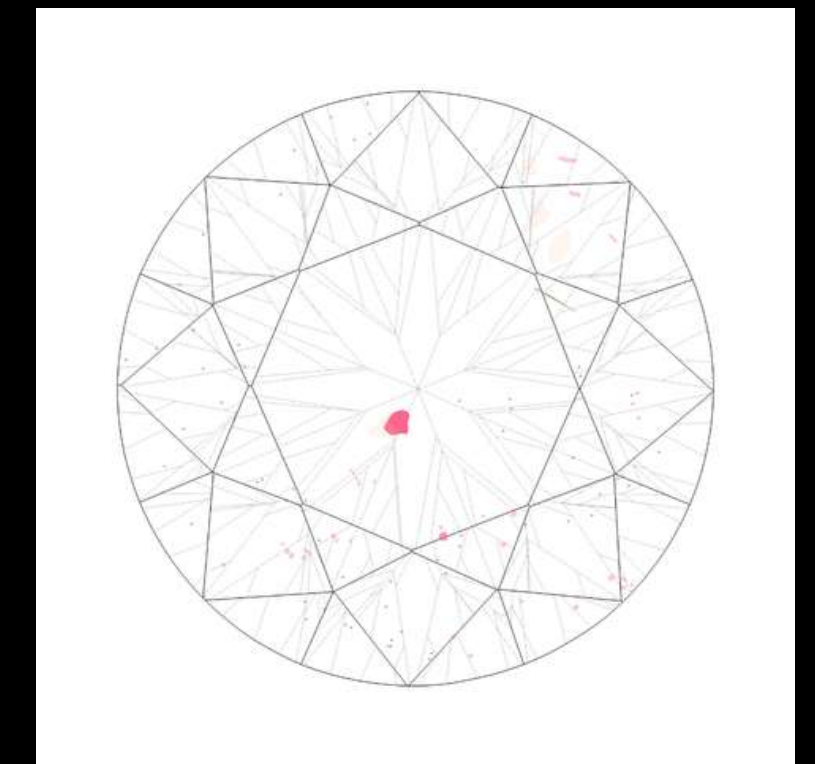

Clarity Diagram

- ◆ Beauty
- ◆ Symmetry
- ◆ Clarity
- ◆ Color
- ◆ Fluorescence



Pavilion color



Table color



Pavilion Fluorescence



Fluorescence



# Conventional Characteristics Graded in Lab: Four Cs

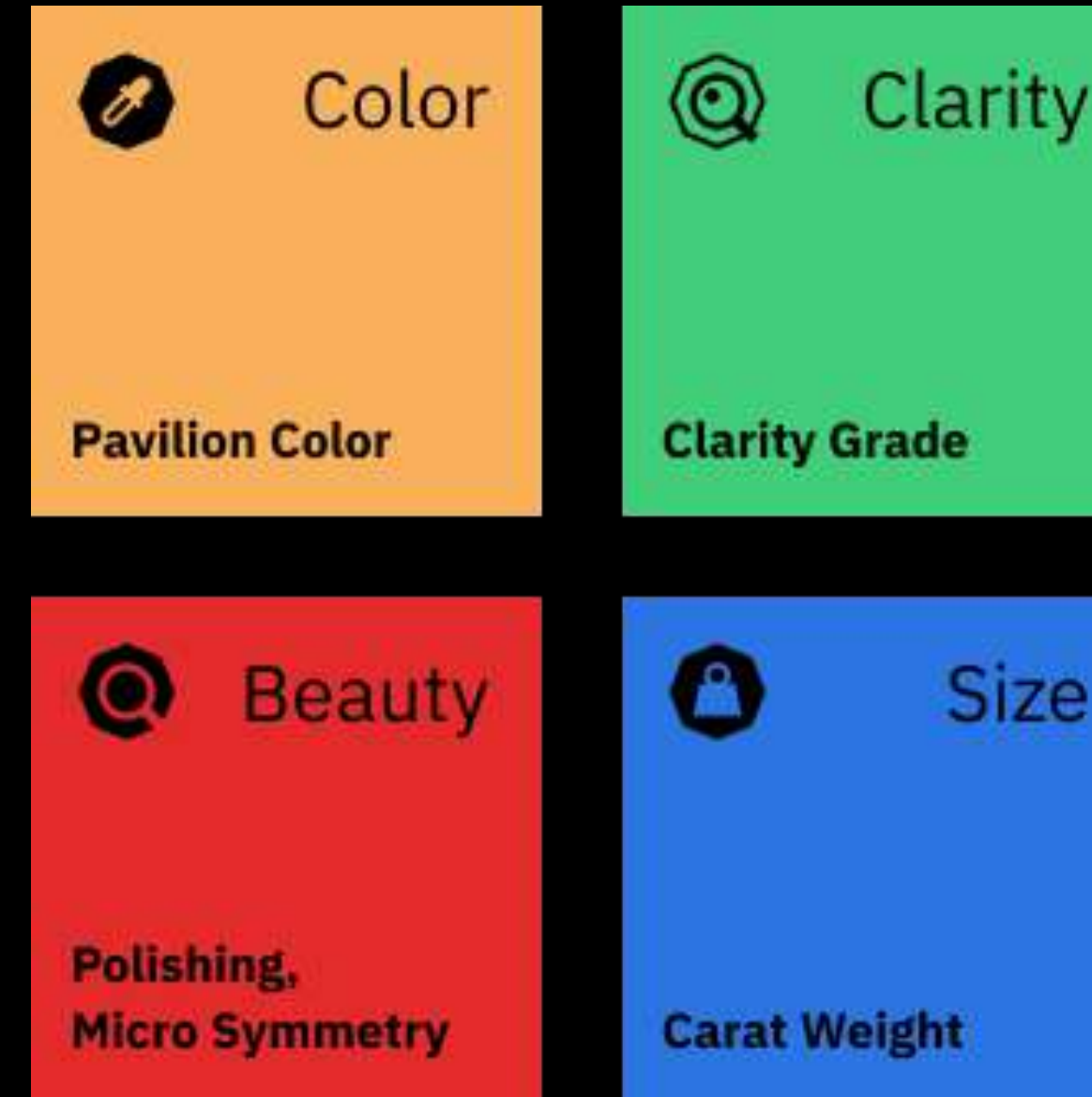



# Conventional Characteristics Graded in Lab: Four Cs

## Diamond characteristics important for Consumer:

- ◆ Fire, Brilliance, Optical Symmetry based on human perception, including stereovision
- ◆ Table Color, Fluorescence
- ◆ Apparent size (Spread)
- ◆ Position of clarity features, diamond transparency



**What Cutwise functions  
can be embedded in your website?**



# Player

Embed any  
single DiBox 2.0  
or ViBox video in  
your site

Available now

[Example 1. Player with Fire video](#)

[Example 2. Player with Darkfield video](#)

The screenshot shows a web browser window displaying a jewelry website. The browser's address bar shows the URL <https://www.your-awesome-site.com/>. The website has a navigation menu with categories: DIAMONDS, ENGAGEMENT RINGS, WEDDING RINGS, JEWELRY, GIFTS, and EDUCATION. The main content area features a large video player showing a close-up of a round cut diamond. To the right of the video player, the product details are listed: "0.73-Carat Round Cut Diamond", "Ideal Cut | G Color | VS2 Clarity", and a price of "\$4,121". Below the price, it states "Bank Wire Price: \$4,059.18". There are two buttons: "ADD THIS DIAMOND" and "ADD TO COMPARISON". A promotional banner offers "Free Shipping, Free Returns" with a deadline of "Monday, July 15". Below this, there is a "View Report" link for GIA. At the bottom, there are "SHARE" and "HINT IT" buttons.



# Visual Widget

Embed all available images and videos

Available now

[Example 1. DiBox 2.0 Media Set](#)

[Example 2. ViBox Media Set](#)

The screenshot shows a web browser window displaying a jewelry website. The browser's address bar shows the URL <https://www.your-awesome-site.com/>. The website header includes a "Live Chat" button, "Sign In", "Wish List", and language options for "English, USD" and "Español". Below the header, the site title "Conventional site" is displayed, along with "Free Shipping, Free Returns" and a search bar. A navigation menu lists categories: DIAMONDS, ENGAGEMENT RINGS, WEDDING RINGS, JEWELRY, GIFTS, and EDUCATION. The breadcrumb trail reads "Home / Diamonds / All Diamonds / LD11777411".

The main content area features a large, high-quality image of a 0.73-carat round cut diamond. A visual widget is overlaid on the bottom left of this image, showing a carousel of diamond images. The first image in the carousel is labeled "DiBox 2.0 Fire" and is highlighted with a white border. Other images in the carousel show different diamond cuts and colors. The text "Powered by OctoNus" is visible at the bottom of the carousel.

To the right of the diamond image, the product details are listed: "0.73-Carat Round Cut Diamond", "Ideal Cut | G Color | VS2 Clarity", and a price of "\$4,121". A "Bank Wire Price: \$4,059.18" is also shown with an information icon. Below the price, there are two buttons: "ADD THIS DIAMOND" (with a dropdown arrow) and "ADD TO COMPARISON".

A promotional banner below the buttons states: "Free Shipping, Free Returns. Order now for free delivery on Monday, July 15 for loose or Tuesday, July 16 when set in jewelry." Below this banner is a "GIA View Report" button. At the bottom of the product section, there are "SHARE" and "HINT IT" buttons.



# Optical Performance Widget

Videos and performance data in one compact component

Available now

[Example 1. EX Round. 1.01ct. G. SI1](#)

[Example 2. Cushion4. 1.04ct. H. VS2](#)

The screenshot shows a web browser window displaying a jewelry website. The page features a navigation bar with links for 'DIAMONDS', 'ENGAGEMENT RINGS', 'WEDDING RINGS', 'JEWELRY', 'GIFTS', and 'EDUCATION'. The main content area is titled 'Conventional site' and displays a product page for a '0.73-Carat Round Cut Diamond'. The diamond is described as having an 'Ideal Cut | G Color | VS2 Clarity' and is priced at '\$4,121'. A 'Bank Wire Price' of '\$4,059.18' is also listed. The page includes buttons for 'ADD THIS DIAMOND' and 'ADD TO COMPARISON'. A 'Free Shipping, Free Returns' banner is present, along with a 'GIA View Report' button. The optical performance widget is prominently displayed, showing a video of the diamond and a performance score of 0.93. The widget also displays the diamond's specifications: 'MSSRBC13', 'EX Round, 0.73ct, G, VS2, EX, EX, NON, +0.1%', and 'LxWxD: 5.84 x 5.83 x 3.55 mm'. The performance score is broken down into categories: Cut Performance (0.93), P (P), F (F), G (G), VG (VG), EX (EX), and OU (OU). The widget is powered by OctoNus.

Google  
https://www.your-awesome-site.com/  
Live Chat  
Sign In | Wish List | English, USD | Español  
Free Shipping, Free Returns | Search | Q |

DIAMONDS ENGAGEMENT RINGS WEDDING RINGS JEWELRY GIFTS EDUCATION

Home / Diamonds / All Diamonds / LD11777411

< Cut Performance Summary Fire Brill >

MSSRBC13  
EX Round, 0.73ct, G, VS2, EX, EX, NON, +0.1%,  
LxWxD: 5.84 x 5.83 x 3.55 mm

★ Cut Performance 0.93 P F G VG EX OU i

Powered by OctoNus

0.73-Carat Round Cut Diamond  
Ideal Cut | G Color | VS2 Clarity  
\$4,121  
Bank Wire Price: \$4,059.18 ⓘ

ADD THIS DIAMOND

ADD TO COMPARISON

Free Shipping, Free Returns  
Order now for free delivery on Monday, July 15 for loose or Tuesday, July 16 when set in jewelry.

GIA  
View Report

SHARE HINT IT



# Customized Widget

Widgets can be  
customized to  
meet your website  
style

By request

The screenshot shows a web browser window displaying a jewelry website. The browser's address bar shows the URL <https://www.your-awesome-site.com/>. The website has a navigation bar with links for "DIAMONDS", "ENGAGEMENT RINGS", "WEDDING RINGS", "JEWELRY", "GIFTS", and "EDUCATION". The main content area features a large image of a diamond with a "Cut Performance" widget overlaid. The widget displays the diamond's ID "MSSRBC13" and its specifications: "EX Round, 0.73ct, G, VS2, EX, EX, NON, +0.1%, LxWxD: 5.84 x 5.83 x 3.55 mm". Below the specifications is a color-coded bar for "Cut Performance" with a score of "0.93" and a grade of "EX". The widget is powered by OctoNus. To the right of the diamond image, the product title is "0.73-Carat Round Cut Diamond" with details "Ideal Cut | G Color | VS2 Clarity" and a price of "\$4,121". A "Bank Wire Price" of "\$4,059.18" is also listed. Below the price are buttons for "ADD THIS DIAMOND" and "ADD TO COMPARISON". A promotional banner offers "Free Shipping, Free Returns" with a deadline of "Monday, July 15". A GIA logo and "View Report" link are also present. At the bottom, there are "SHARE" and "HINT IT" buttons.

Google  
https://www.your-awesome-site.com/  
Live Chat  
Sign In | Wish List | English, USD | Español  
Free Shipping, Free Returns | Search | Q |

DIAMONDS ENGAGEMENT RINGS WEDDING RINGS JEWELRY GIFTS EDUCATION

Home / Diamonds / All Diamonds / LD11777411

< Cut Performance Summary Fire Brilliance >

MSSRBC13  
EX Round, 0.73ct, G, VS2, EX, EX, NON, +0.1%,  
LxWxD: 5.84 x 5.83 x 3.55 mm

Cut Performance 0.93 P F G VG EX OU i  
Powered by OctoNus

0.73-Carat Round Cut Diamond  
Ideal Cut | G Color | VS2 Clarity  
\$4,121  
Bank Wire Price: \$4,059.18 ⓘ

ADD THIS DIAMOND  
ADD TO COMPARISON

Free Shipping, Free Returns  
Order now for free delivery on Monday, July 15 for loose or Tuesday, July 16 when set in jewelry.

GIA  
View Report

SHARE HINT IT



# Optical Performance Full Report

All info at a glance.  
Can be opened from your catalog

August 2019

[Example 1. Pear. 0.9ct. H. SI1\(+rough\)](#)

[Example 2. MSSMARQUISE. 0.54ct. F. VS2](#)

Conventional site

DIAMONDS ENGAGEMENT RINGS WEDDING RINGS JEWELRY GIFTS EDUCATION

Home / Diamonds / All Diamonds / LD11777411

Summary Clarity Plotting Polish

Powered by OctoNus

### MSSRBC13

Measurements: 5.84 x 5.83 - 3.55mm (60.8%)

Grades			
Shape	Round	Cut	Excellent
Carat Weight	0.73ct	Polish	Excellent
Color	G	Symmetry	Excellent
Clarity	VS2	Fluorescence	None
Inclusion Details	--		
Girdle	Thin, Medium		
Certificate	GIA 2135273512		

Optical Performance Evaluation			
Cut Performance	0.93	P F G VG EX OU	
Fire	0.72	P F G VG EX OU	
Brilliance	1	P F G VG EX OU	
Optical Symmetry	8.57	P F G VG EX OU	
Spread	0ct	+0.1%	
Face-Up Fluorescence	VSTR STR MED FNT NON 100%		

100% Cut Performance Grade

100% Brilliance Grade

99% Fire Grade

+0.10% Spread, %

8.57 Optical Symmetry

G Color

VS2 Clarity

EX Cut Quality

Show Reference

DiBox 2.0 Fire DiBox 2.0 Office Face-up Fluor. Live Photo Darkfield ASET Black Live Photo Pavilion Color Lab Live Photo Table Color Lab Live Photo Darkfield Photo Arrows Hearts Table Color UV Free Table Color Lab Table Color Outdoor Pavilion Color Lab Office Black ASET



# Comparison Widget

Makes possible to compare different cuts

Q4 2019

Results (41,798) | Recently Viewed (0) | Comparison (2)

Compare	Shape	Carat	Color	Clarity	Cut	Report	Origin	Price	
<input checked="" type="checkbox"/>	Cushion	0.50	H	VS1	Excellent	GIA	Botswana Sort	\$800	<a href="#">View</a>
<input checked="" type="checkbox"/>	Round	0.30	D	VVS2	Excellent	GIA	Botswana Sort	\$790	<a href="#">View</a>

**Comparison Metrics:**

- Cut Performance Grade: 96% vs 98%
- Brilliance Grade: 97% vs 99%
- Fire Grade: 89% vs 95%
- Spread, %: -21.7% vs -3.1%
- Optical Symmetry: 7.04 vs 7.85
- Color: H vs D
- Cut Quality: EX vs EX

**Comparison Table:**

	Cushion	Round
Product SKU	Cushion	Round
Fire		
ASET		
Carat Weight	0.50ct	0.30ct
Cut Perform	1.07	1.13
	P F G VG <b>EX</b> OU	P F G VG <b>EX</b> OU

**Diamond Information:**

[View Diamond](#)

Table: 58 %  
Depth: 67.7 2.96mm  
Girdle: Slightly Thick - Very Thick  
Culet: None

Stock Number: 3352170A | Price: \$800  
Shape: | Cut:



# Integration Options

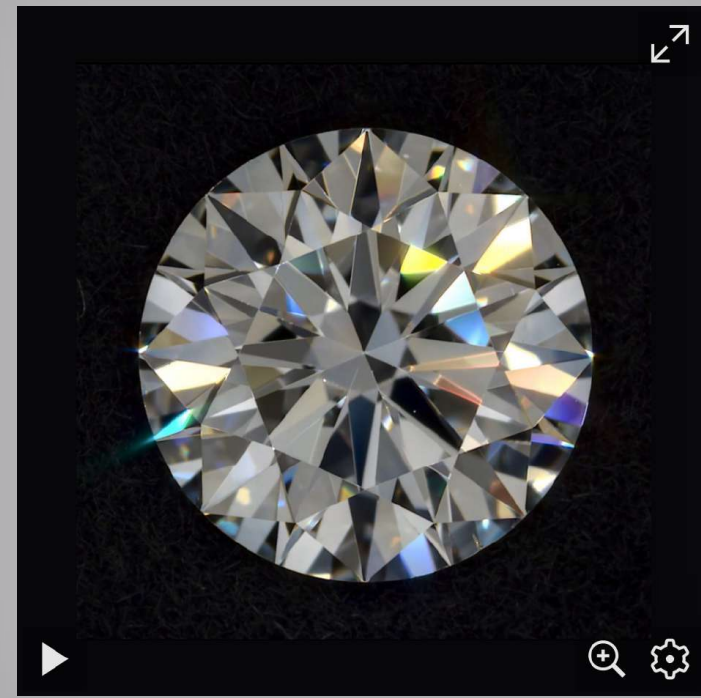

Player

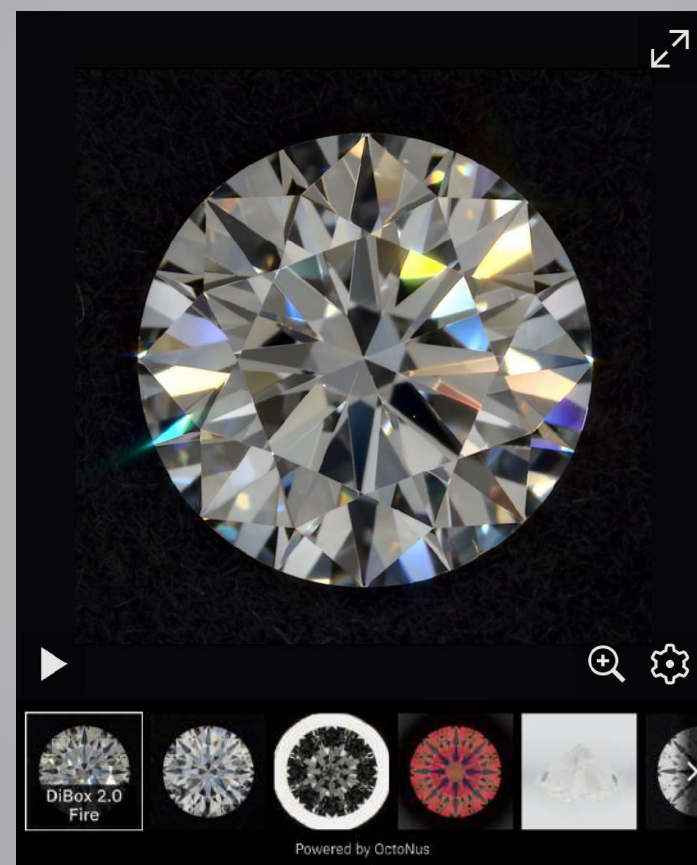

Visual Widget

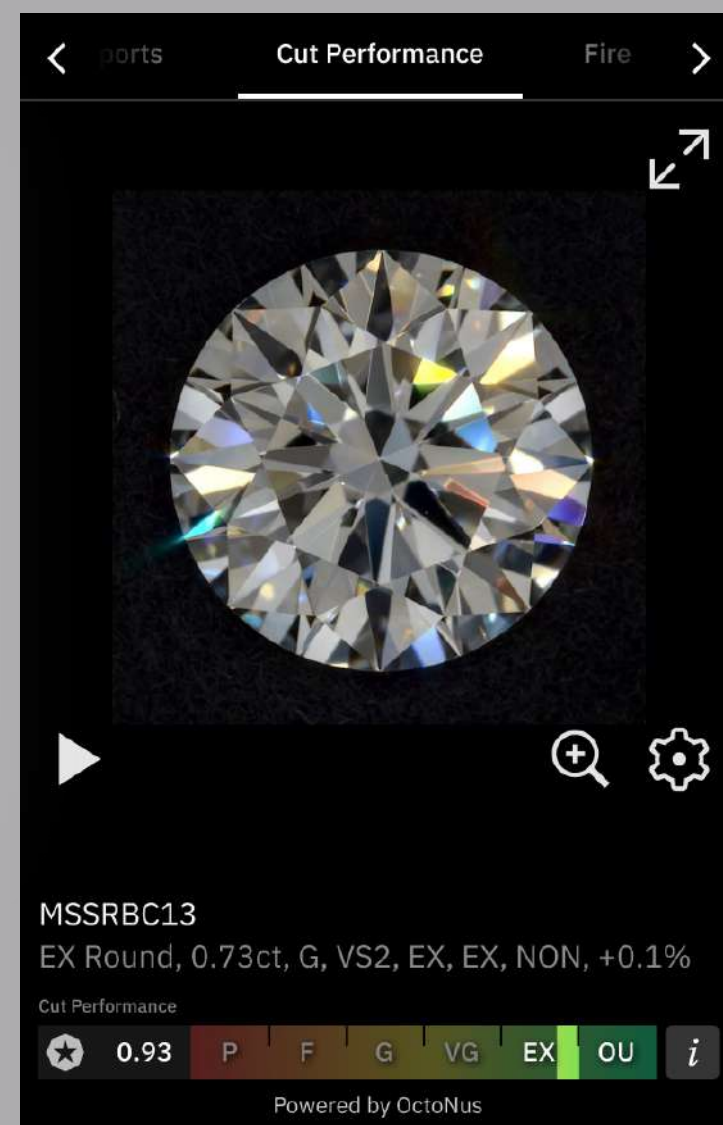

Optical Performance Widget

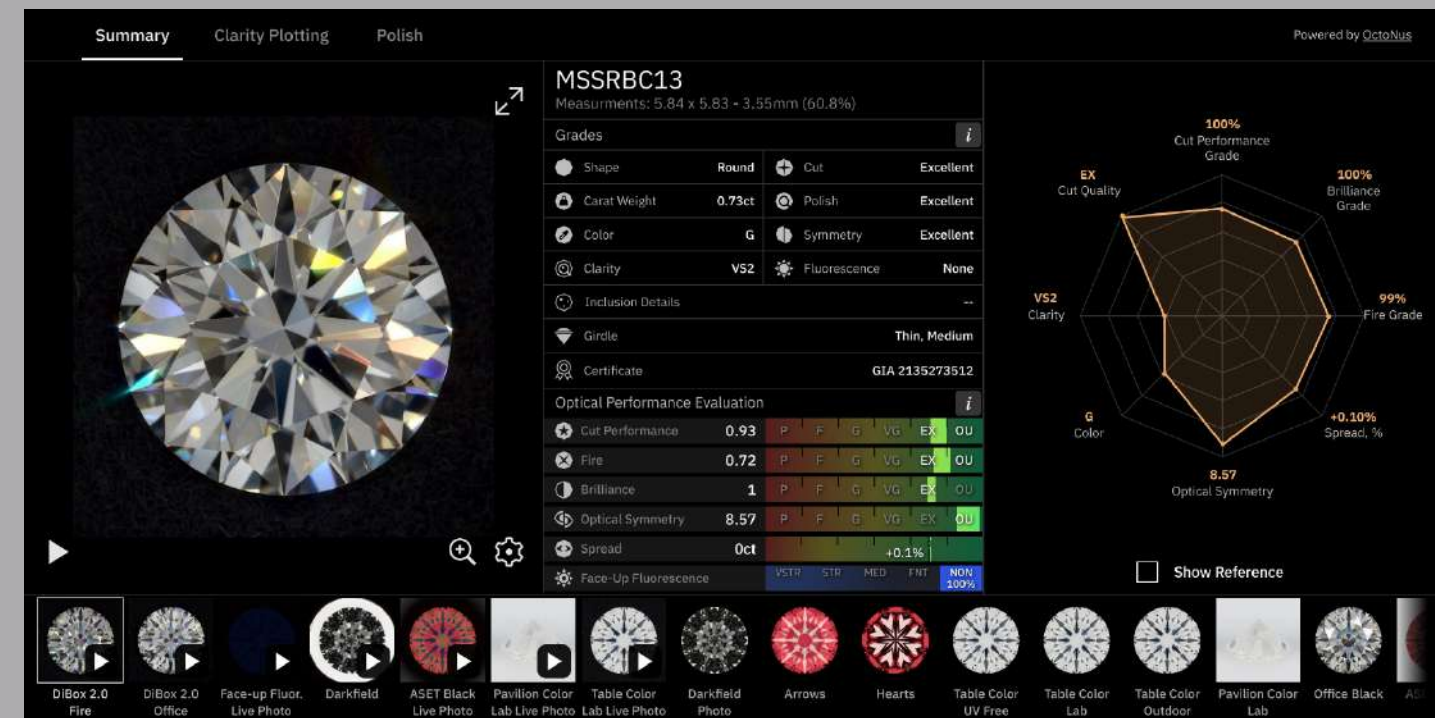

Optical Performance Full Report

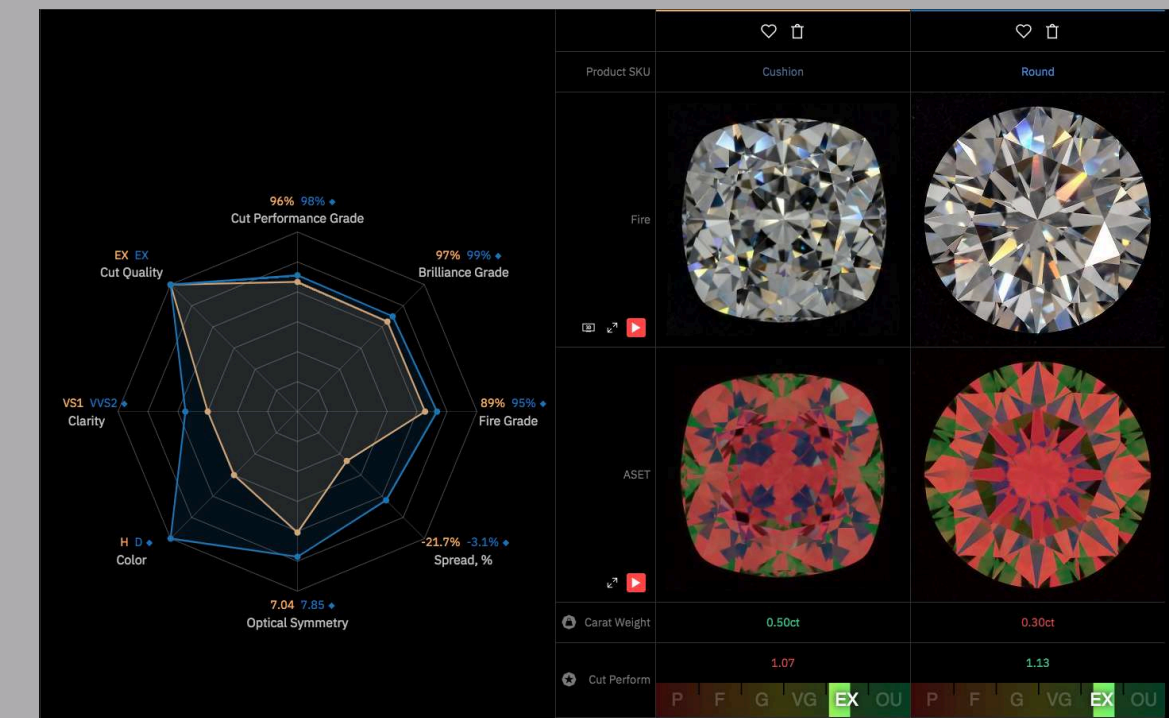

Comparison Widget



# Integration with RapNet

Data from Cutwise can be embedded in RapNet

Available now

The screenshot displays the RapNet website interface. At the top, there's a navigation bar with options like 'Live Chat', 'Sign In', 'Wish List', and language selection ('English, USD', 'Español'). Below this is a search bar and various filters. The main content area shows a list of diamonds, with one selected. A 'Media' modal is open, showing a video player. The video player has tabs for 'Lab Report', 'Diagram', 'Images', and 'Video'. The video is titled 'Cut Performance' and shows a close-up of a diamond. Below the video, there's a summary of the diamond's characteristics: 'EX Round, 2.60ct, I, VS2, EX, EX, NON, -3.4%'. The video player also shows a 'Cut Performance' score of 1.16 and a color grade of 'EX'. The background shows a table of diamonds with columns for 'Diamon...', 'SEARCH', 'TRADESCR...', 'RAPAPORT PRICES', 'MANAGE MY DIAMONDS', 'UPLOAD DIAMONDS', 'SAVED SEARCHES', and 'TRACKED DIAMONDS'. A 'Diamond Details' section is visible, listing attributes like Shape (Round), Size (2.60), Color (I), Clarity (VS2), Cut (EX), Polish (EX), Symmetry (Excellent), Fluorescence (None), Depth % (62.3%), Table % (57%), and Measurements (8.72-8.77x5.45). A 'Seller Details' section for 'Octonus' is also visible, showing location (INDIA), contact person (Sergey), and phone number (114203). A 'Total' of \$19,110 is shown. At the bottom, there's a summary for the page: 'Totals for this page: 6 diamonds | Carat: 15.6 | Average Price: \$21,809 | Average Price/Ct.: \$8,388 | Average Discount: -20.10% | Total Price: \$130,854'. A 'Show 50 Results' button is at the bottom right.



# Integration Workflow

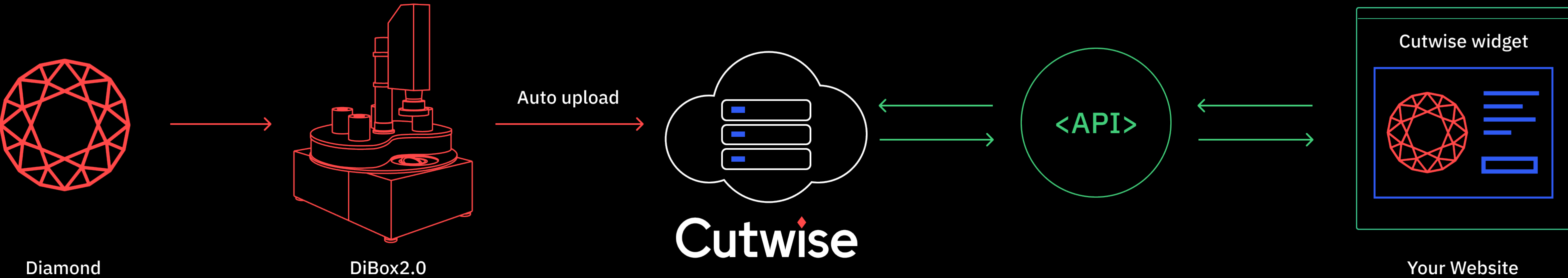

# Cutwise Widgets Technical Benefits



# Adaptive layout (phones, tablets, laptops, widescreen displays, 4K TVs)

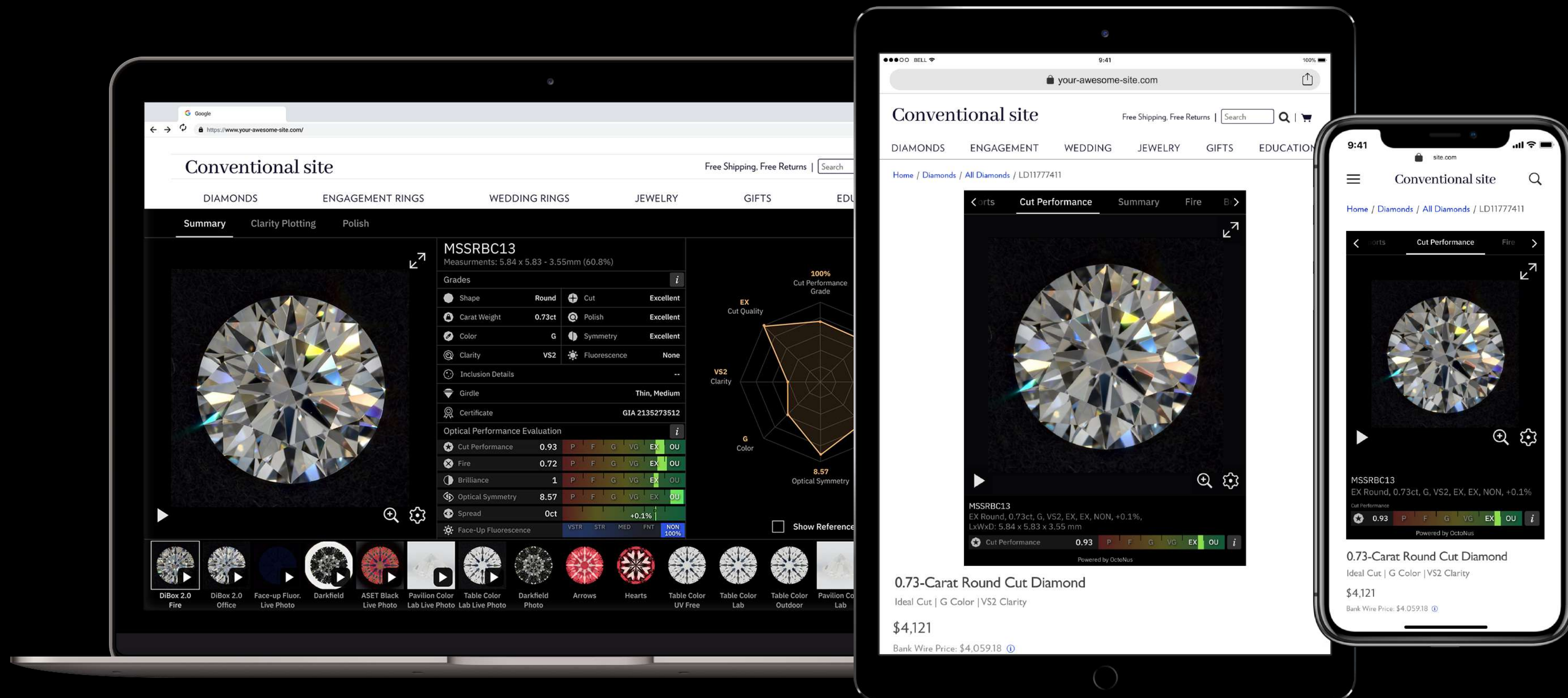



# HiDPI (Retina) displays support





Adaptive media for any devices, high quality and traffic economy

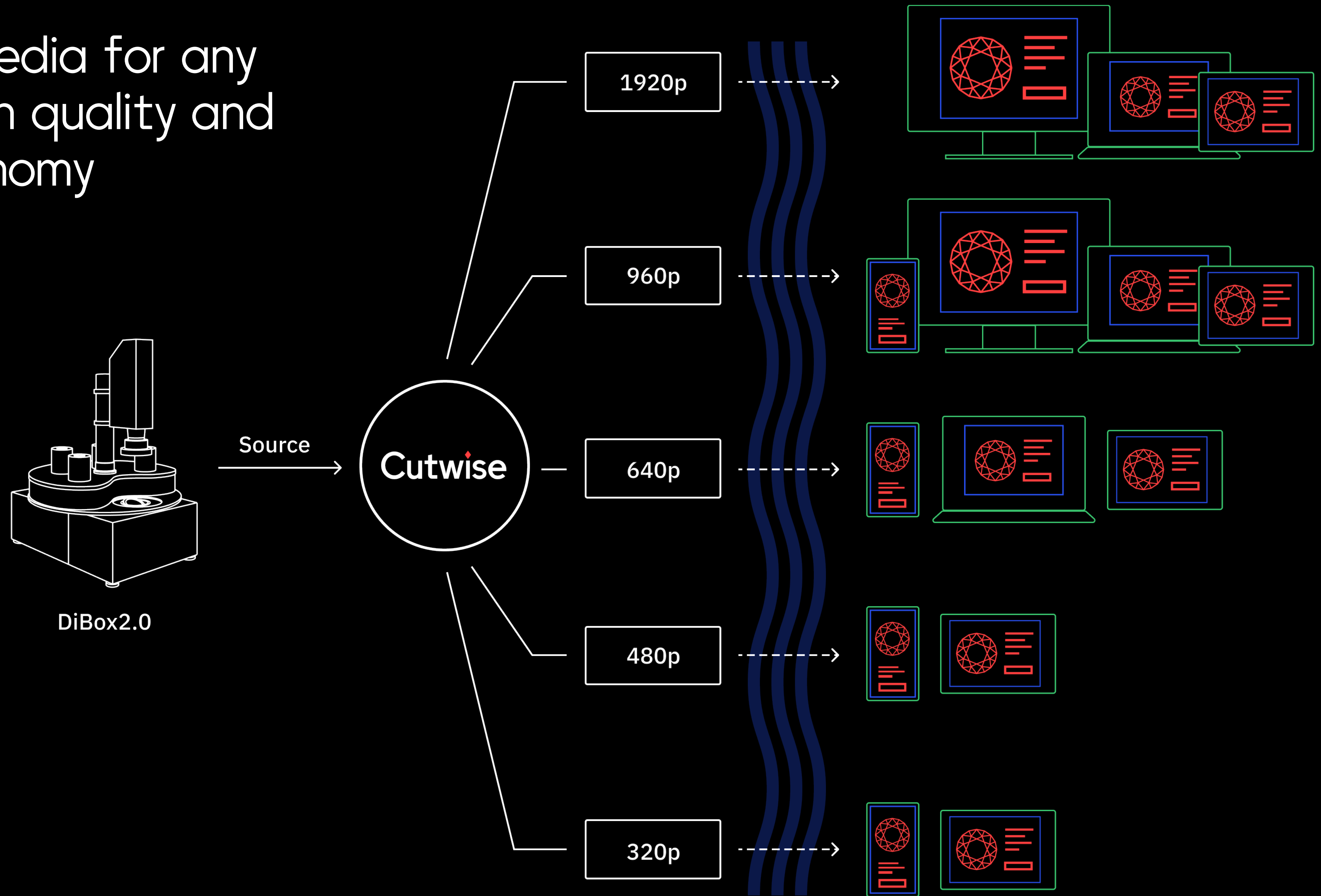

CDN (Content delivery network),  
fast content delivery to any  
place in the world.





# Usage examples

# Usage examples

MENU DIAMONDS

ALROSA ABOUT US FOR PARTNERS

HOME / DIAMONDS / ID 17044857

₹ 669 780

ADD TO CART

REQUEST A VIEWING

SHAPE	CARAT	COLOR	CLARITY	CUT	AGE, MLN YEARS	DIAMOND ORIGIN	YEAR OF MINING	PRICE, RUB
ROUND	1.51	G	VVS2	EXCELLENT	350	YAKUTIA	2017	669 780

Player integration

## ALROSA

Player integration



# Usage examples

## DHARMANANDAN

Only video and optical performance data were used

SIRIUS STAR® CUSHION  
CUTWISE PROFILE

Optical Light Performance Report

Brilliance O.Symme H & A 360 View Light



Grades		DD - RSFCA001	
Shape	SIRIUS STAR CUSHION	Cut Quality	-
Carat Weight	1.015 ct	Polish	VG
Color	F	Symmetry	VG
Clarity	VS2	Fluorescence	NONE

Optical Performance Evaluation

Cut Performance	0.89	P F G <b>EX</b> OU
Fire	0.60	P F <b>VG</b> EX OU
Brilliance	0.98	P F G <b>VG</b> EX OU
Optical Symmetry	6.26	P F G <b>VG</b> EX OU
Face-up Fluorescence		VSTR STR MED FHT <b>NON 100%</b>

Powered by OctoNus

# Usage examples

IGI

Only video was used





# Usage examples

OEM  
customized  
solutions

The screenshot displays the Logoweb website interface for diamond auctions. At the top, there are navigation links for "BID NOW", "SCHEDULE VIEWING", and "SIGN IN". Below the site name, there are tabs for "COLORLESS POLISHED", "FANCY COLOR POLISHED", and "ROUGH". A search bar shows "Your recent searches" and a "Hide All Filters" button. The main filter area includes diamond shape icons (Round, Oval, Marquise, Cushion, Princess, Pear, Radiant, Emerald, Ascher, Heart), "CARAT WEIGHT" (0.19 - 1.99), and "CERTIFICATE" options (GIA, IIDGR, HRD). There are sliders for "COLOR" (D-K), "CUT QUALITY" (Excellent to Poor), "CLARITY" (FL to SI2), "FLUORESCENCE STRENGTH" (None to Very Strong), "SYMMETRY" (Excellent to Poor), and "POLISH" (Excellent to Poor). An "AUCTION" section allows filtering by "AUCTION CYCLE" and "AUCTION DATE". A "SELLER" section has checkboxes for "Auction Sales" and "Auction Sales Registered Seller". A search bar "Filter by lot name" and a "Clear All" button are also present. Below the filters, it states "Products found: 92". The bottom section shows a "VIEW MEDIA" toolbar, "SORT BY" options (Media Relevance, Date, Price, Carat, Color, Clarity), and "SHOW" options (Grayscale, Single scale, Descriptions). The product listings are displayed in a grid, with the first row showing five items: "Cycle 8. Lot 4001" (EX Oval, 3.61ct, G, VVS1, EX, EX, NON, -5.21%), "Cycle 8. Lot 4002" (EX Cushion, 3.61ct, G, VVS1, EX, EX, NON, -5.21%), "Cycle 8. Lot 4003" (EX Pear, 3.61ct, G, VVS1, EX, EX, NON, -5.21%), "Cycle 8. Lot 4004" (EX Round, 2.57ct, G, VVS1, EX, EX, NON, -5.21%), and "Cycle 8. Lot 4005" (EX Round, 3.61ct, G, VVS1, EX, EX, NON, -5.21%). Each listing includes a diamond image, a "NEW" badge, and a star icon.

Thank you

Cutwise

DiBox<sub>2.0</sub>

O<sup>n</sup>octonus

LDX7